

VILLAGE OF POINT VENTURE, TEXAS

ORDINANCE NO. 2021-02-17

AN ORDINANCE OF THE VILLAGE OF POINT VENTURE, TEXAS; AMENDING CHAPTER 4, "BUILDING REGULATIONS", OF THE VILLAGE'S CODE OF ORDINANCES, TO ADD ARTICLE 4.08, "OUTDOOR/EXTERIOR LIGHTING"; PROVIDING CRIMINAL PENALTIES UP TO \$500.00 PER VIOLATION; PROVIDING REPEALER, SEVERABILITY, AND SAVING CLAUSES; AND PROVIDING FOR AN EFFECTIVE DATE.

WHEREAS, the Village Council of the Village of Point Venture, Texas (the "Village Council") seeks to provide for the regulation of lighting within the corporate limits of the Village of Point Venture, Texas (the "Village"); and

WHEREAS, the Village Council seeks to maintain the value of Point Venture and its scenic beauty and rural charm, which are the keystones of the Village's quality of life, through a comprehensive regulatory program that includes subdivision control and restrictions on signs and lighting; and

WHEREAS, the Village Council finds that unnecessary and improperly designed light fixtures cause glare, light pollution and wasted resources; and

WHEREAS, glare and light pollution can result in: hazardous circulation conditions for all modes of transportation; the diminishing ability to view the night sky; light trespass; and unattractive townscape; and

WHEREAS, the people who live in and near Point Venture value the natural environment, including the beauty and high quality of the night sky; and

WHEREAS, Point Venture desires to protect the health, safety and welfare of the general public, and to protect the night sky that adds to the quality of life and economic well-being of the Village; and

WHEREAS, these lighting regulations will not sacrifice the safety of our citizens or visitors, or the security of property, but instead will result in safer, efficient and more cost-effective lighting; and

WHEREAS, pursuant to Texas Local Government Code Section 51.001, the Village has general authority to adopt an ordinance or police regulation that is for the good government, peace or order of the Village and is necessary or proper for carrying out a power granted by law to the Village; and

WHEREAS, the Village Council finds that it is necessary and proper for the good government, peace or order of Point Venture to adopt an ordinance regulating lighting.

NOW THEREFORE, be it ordained by the Village Council of the Village of Point Venture, Texas:

Section 1. Findings of Fact. All of the above premises are hereby found to be true and correct legislative and factual findings of the Village Council of Point Venture, Texas, and are hereby approved and incorporated into the body of this Ordinance as if copied in their entirety.

Section 2. Amendments. Chapter 4, "Building Regulations", of the Village's Code of Ordinances is amended to add Article 4.08, "Outdoor/Exterior Lighting", to read entirely as follows:

ARTICLE 4.08 OUTDOOR/EXTERIOR LIGHTING

Sec. 4.08.001 Purpose

The regulation and limitation of outdoor or exterior lighting is intended to reduce or prevent light pollution. While effective outdoor lighting is necessary for safety and security, ill-advised exterior lighting can contribute to unwarranted glare and light trespass while failing to maintain desirable levels of energy efficiency. In addition to more energy efficient and cost-effective lighting, a dark and visible night sky has potential aesthetic, ecological and economic benefits.

Sec. 4.08.002 Definitions

Words and phrases used in this article shall have the meanings set forth in this section. Terms that are not defined below, but are defined elsewhere in the Code of Ordinances, shall be given the meanings set forth therein. Words and phrases not defined in the Code of Ordinances shall be given their common, ordinary meaning unless the context clearly requires otherwise.

Applicant means a person or entity who submits an application for a required approval. To be qualified as an applicant, the person or entity must have sufficiently documented legal authority or proprietary interests in the land to commence and maintain proceedings. To avoid confusion, the term will not include anyone other than the property owner(s) or a duly authorized agent and representative of the property owner.

City means the Village of Point Venture, an incorporated municipality located in Travis County, Texas.

Full cutoff fixture means a fixture, as installed, that is designed or shielded in such a manner that all light emitted by the fixture, either directly from the luminaires or indirectly from the fixture, is prevented above a horizontal plane running through the lowest point on the fixture where light is emitted.

Holiday lighting means temporary lighting used for a specific celebration of one of the following types: festoon type low output lamps, limited to small individual bulbs on a string; low-output lamps used to internally illuminate yard art; or flood or spot lights producing less than 2,000

lumens each.

Initial lamp lumen means the product of the initial number of lumens produced by the light emitting elements of an individual luminaire, multiplied by the luminaire efficiency. If the efficiency is not known, assume 70 percent for a single-family or two-family residential luminaire and 100 percent for a multifamily or nonresidential luminaire.

Lamp or bulb means the light-producing source installed in a luminaire.

Light Pollution means any adverse impact of artificial light including, but not limited to: light trespass, uplighting, uncomfortable distractions to the eye, or any artificial light that diminishes the ability to view the night sky. The term is often used to denote urban sky glow.

Light trespass means light emitted from fixtures that causes light to be cast on a property other than the one where it is installed, upwards toward the sky or any other location where it is not wanted or needed.

Lighting means any source of light other than natural light emitted from celestial objects or fire. The term includes any type of lighting, fixed or movable, and designed or used for illumination of buildings or homes, including but not limited to: streetlights, canopies, searchlights, externally or internally on signs, and luminous elements and fixtures attached to buildings, structures, poles, ground mounted or any other location.

Logo means a representation or symbol adopted by a business, organization, or an individual that is used to promote instant public recognition.

Lumen means a unit of measurement that quantifies the amount of light produced by a lamp or bulb or emitted from a fixture (as distinct from "watt," a measure of power consumption). The lumen rating associated with a given lamp is typically indicated on its packaging or available from the manufacturer.

Lumens per acre means the total number of initial lamp lumens produced by all fixtures utilized in outdoor lighting on a property divided by the total area of the property in acres, or part of an acre.

Luminaire means the complete lighting unit, including the lamp, the fixture and other parts or components.

Outdoor or Exterior lighting means temporary or permanent lighting that is installed, located or used in such a manner to cause light to be cast outdoors. Any multifamily or nonresidential fixture that is installed indoors but causes light to shine outside is considered outdoor lighting for the purpose of administering these regulations (See figure A).

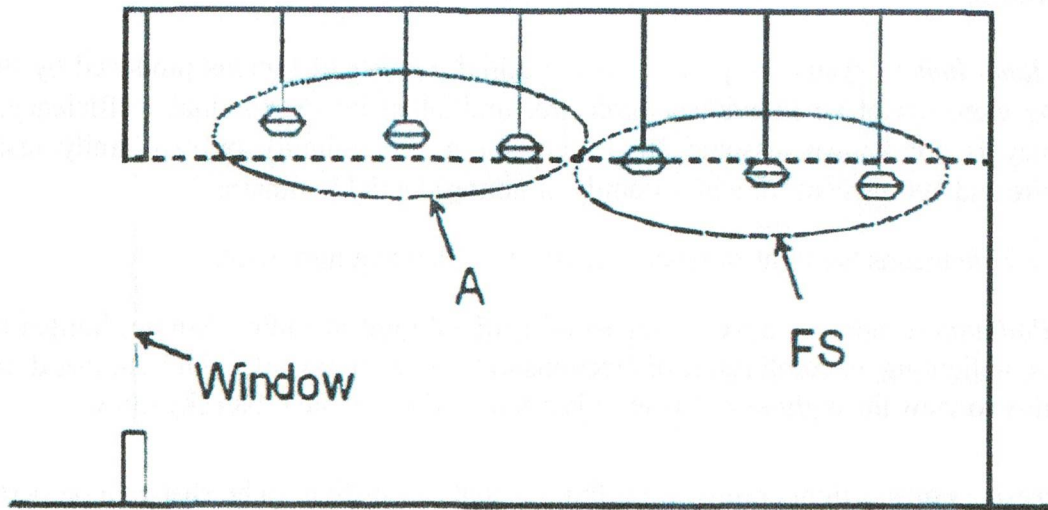

Figure A: Elevation view showing an application of indoor lighting, labeled 'FS,' which is subject to these requirements and indoor lighting, labeled 'A,' which is installed so that it is typically not subject to these requirements.

Temporary lighting means lighting intended for uses of a limited duration; such as holiday decorations, civic events or construction projects.

Total outdoor light output means the total amount of light, as determined by the sum of the initial lamp lumens attributed to each outdoor or exterior light fixture located on the property.

Uplighting means lighting that causes light rays to project above a horizontal plane running through the lowest point on the fixture where light is emitted.

Sec. 4.08.003 Scope and Applicability

All outdoor or exterior lighting shall be installed in conformance with the provisions of this article, applicable electrical codes, energy codes, and building codes, except as provided herein.

A. New Construction. All outdoor or exterior lighting associated with newly constructed residential and nonresidential structures permitted after the effective date of this article shall comply with these requirements and other applicable regulations unless otherwise exempted.

B. Renovations and Repairs. All residential and nonresidential renovations or repairs requiring a permit after the effective date of this article shall comply with these requirements and other applicable regulations unless otherwise exempted. All renovations or repairs that include installation or replacement of exterior or outdoor lighting in excess of 6,200 lumens within any

90-day period shall require a permit.

C. Nonconforming Existing Lighting. All luminaries lawfully in place prior to the date of the ordinance from which this division is derived shall be considered as having legal nonconforming status. However, any luminary that replaces a legal nonconforming luminary, or any legal nonconforming luminary that is moved, must meet the standards of this division, subject to the following conditions.

- (1) If a person makes any change or addition to an existing lighting system, the change or additional shall conform to the provisions for this division.
- (2) If a person makes any change or addition to an existing building which results in an increase in the size of the building by more than twenty percent (20%), the person shall ensure that all existing outdoor lighting shall conform to the provisions of this division.
- (3) Street Lighting. Non-conforming street lights shall be allowed to remain until replacement is otherwise required. Replacement fixtures and lamps shall comply with the requirements of this article as specified below.

D. Emptions and Exceptions.

- (1) Outdoor or exterior lighting fixtures, including landscape lighting with a maximum output (regardless of the number of lamps) of 800 lumens per fixture for shielded fixtures, and 450 lumens per fixture for unshielded fixtures. However, the collective output from these fixtures shall be included in the total output limitation specified below.
- (2) Lighting produced directly or indirectly by the combustion of natural gas, liquid propane or other fossil fuels.
- (3) Nonconforming sports facility lighting prior to 11:00 p.m. or later if required to complete an event in progress prior to that time.
- (4) Flag or flag pole lighting.
- (5) Holiday lights from November 15th to January 15th between 6:00 a.m. and midnight, except that flashing holiday lights are prohibited on nonresidential properties and discouraged on residential properties.
- (6) Temporary lighting for events or construction areas provided the lights do not present a traffic hazard.
- (7) Traffic control signals or devices and specialized or temporary lighting needed for safety, during emergency repairs or by law enforcement, fire and emergency services.

(8) Lighting required by federal or state laws or regulations, including those required to be installed on motor vehicles or for the safe operation of aircraft.

(9) Security lighting that is motion sensor activated and remains active no longer than five minutes after motion on the property has ceased.

Sec. 4.08.004 Procedures and Compliance

A. Single-family and Two-family Residential Outdoor Lighting.

(1) Upon receipt of single-family or two-family residential building permit application, Village Building Services shall provide either a summary or a copy of these requirements. Continued pursuit of a permit shall serve as acknowledgment that the applicant has been notified of these outdoor lighting regulations.

(2) Compliance with outdoor lighting requirements for single-family or two-family residences will be reviewed onsite, and verified before issuance of a Certificate of Occupancy. A separate lighting permit apart from the building permit is not required. However, the Assistant Building Official may require manufacturer's data on any outdoor light fixture or lamp as part of that review.

B. Multifamily and Nonresidential Outdoor Lighting. All applications for multifamily and nonresidential building permits or land use planning review, including subdivision construction plans, which include installation of outdoor lighting fixtures shall include lighting plans conforming to the provisions of these regulations. Submittals shall include the following information as applicable to each specific project:

(1) Plans indicating the location, type, intensity, and height of all existing and proposed outdoor light fixtures, including those indoor fixtures defined as outdoor or exterior lighting by these provisions;

(2) Specifications and descriptions of all fixtures, including lamps, photometric data showing the pattern of light emission and intensity, shielding devices, light standards or other supports, which may be provided as manufacturer's standard literature;

(3) Calculations of the total outdoor light output, the total outdoor light output per acre, the total illuminated property area and both the fixture and lamp data used in the calculations; and

(4) Additional information requested by P&Z Commission and Assistant Building Official and required to verify compliance.

C. Compliance.

(1) These regulations are not intended to prohibit the use of any design, materials,

methods or operation not specifically prescribed herein, provided such alternative has been approved by Assistant Building Official, upon a finding that:

- (a) The alternative meets or exceeds the applicable standard, and
- (b) The alternative is otherwise satisfactory and consistent with the legislative intent of these regulations.

D. Enforcement.

- (1) The city shall have the power to administer and enforce the provisions of this article as specified in Sec. 1.01.009 of the Point Venture Code of Ordinances.
- (2) In case any lighting fixture or structure is erected, constructed or reconstructed, altered, repaired or converted is found to be in violation of this ordinance, the Building Official or designated city official shall institute any appropriate action to put an end to such violation.
- (3) Right of Entry. Upon presentation of proper credentials at the request of the land occupier or owner, the Building Official or designated city official may enter upon any property, vacant lots, or premises in the City to perform any duty imposed by this article.
- (4) Stop Work. The Building Official or designated city official may issue a Stop Work Order to immediately halt work on a property that is in violation of this article. Such order may permit limited work to occur that is necessary to stabilize and secure the site.
- (5) Notice of Violation.
 - (a) If the Building Official or designated city official has reason to believe that any of the provisions of this article are being violated, he/she shall provide or send a written Notice of Violation to the person responsible for such violation(s). Such notice shall state the nature of the violation(s) and provide a thirty (30) day grace period to correct the violation(s).
 - (b) Notice of violation shall be given by certified mail addressed to the owner at the owner's address as recorded in the appraisal district records of the appraisal district in which the property is located. A notice returned "refused" or "unclaimed" does not affect the validity of the notice and notice is considered delivered.
 - (c) If at the end of the 30-day grace period the violation has not, in the judgment of the Building Official or designated city official, been satisfactorily corrected, then civil and/or criminal penalties and other remedies available by law shall be sought.

E. Violation; Penalties.

(1) Any violation of this article is hereby declared to be a public nuisance, justifying the use of any or all remedies available for abatement as specified in those provisions.

(2) It shall be unlawful for a person, firm or corporation to locate, erect, construct, reconstruct, enlarge, change, maintain, or use any light structure or fixture which emits light onto the property of another in violation of this article.

(3) Any person, firm or corporation who violates any provision of this article shall be deemed guilty of a misdemeanor, and upon conviction therefore, shall be subject to a fine not to exceed the sum of five hundred dollars (\$500.00) for each offense, and each and every day any such offense shall continue shall be deemed to constitute a separate offense.

(4) The penal provisions imposed under this Ordinance shall not preclude Point Venture from filing suit to enjoin the violation. Point Venture retains all legal rights and remedies available to it pursuant to local, state and federal law.

Sec. 4.08.005 Lamps, Fixtures, Shielding and Output Limits

A. Governmental Owned Street Lights.

(1) Governmental owned streetlights shall be full cut-off fixtures in order to limit light trespass (see Figure B). To the extent government owned streetlights are replaced or repaired with a light emitting diode (LED) luminaire, the LED luminaire shall have a correlated color temperature not to exceed 3,000 Kelvin. Streetlights associated with new development shall comply with additional requirements contained in the Village's Code of Ordinances.

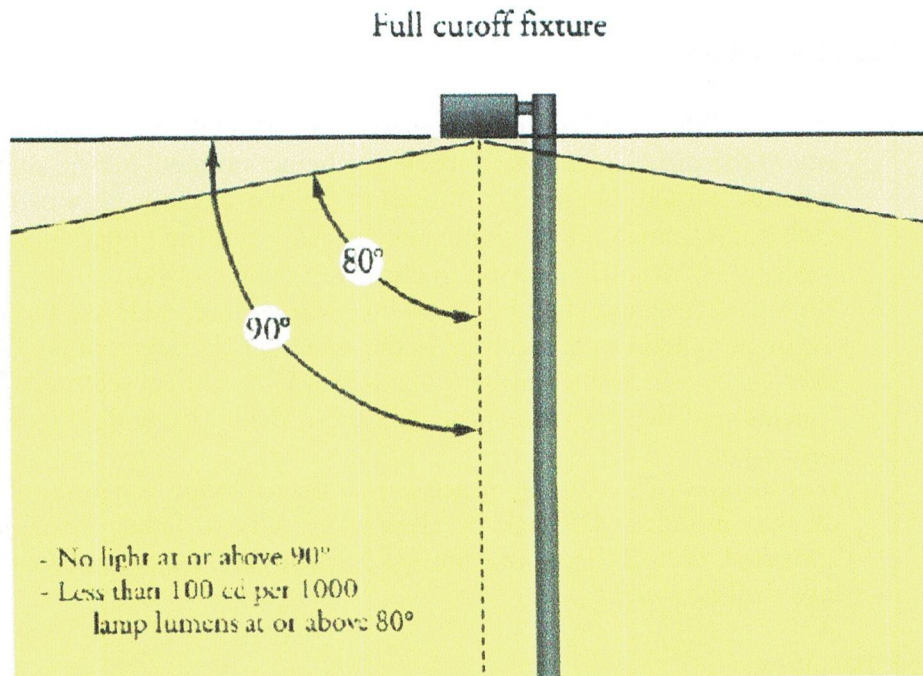

Figure B: Full cutoff fixtures do not allow any light to be emitted above the fixture.

B. Shielding.

- (1) All outdoor lighting, except governmental owned streetlights, shall be shielded (see Figures C and D).

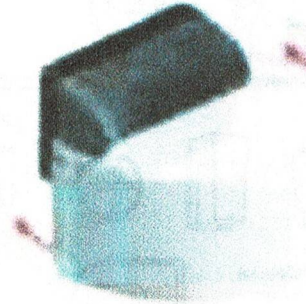
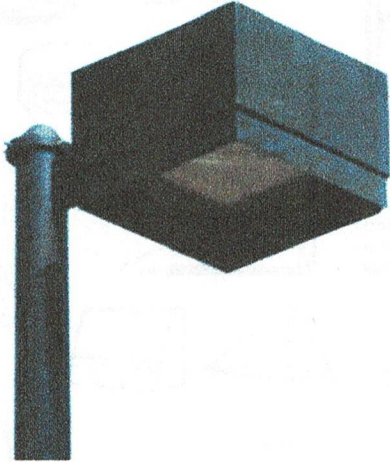

Figure C: Mounting height or proximity to property lines may cause the lamp. Above are two examples of shielding.

Space Intentionally Left Blank

Examples of Acceptable / Unacceptable Lighting Fixtures

Unacceptable / Do Not Use

Fixtures that produce glare and light trespass

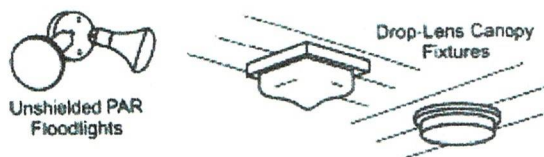
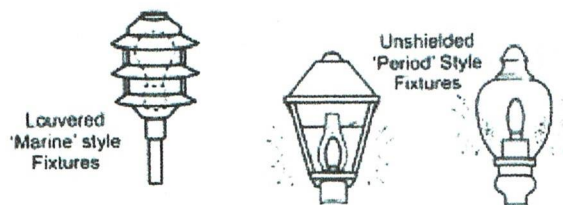
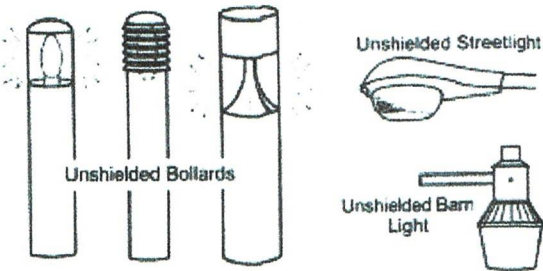
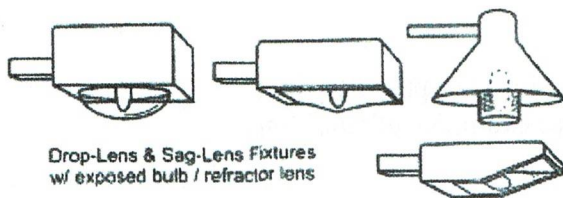
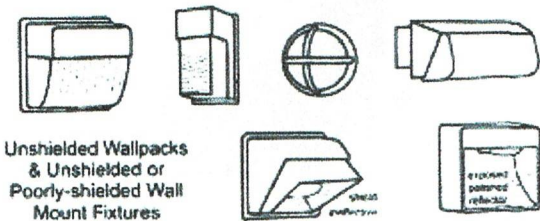
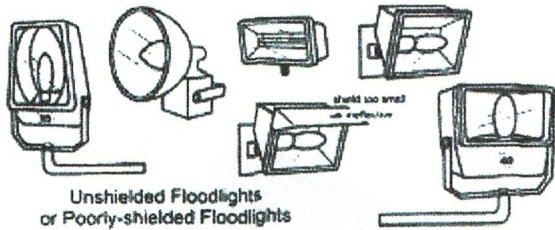

Usually Acceptable / May Need Shielding

Fixtures that shield the light source to minimize glare and light trespass and to facilitate better vision at night

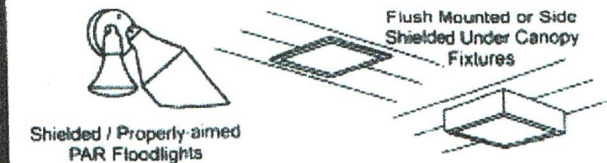
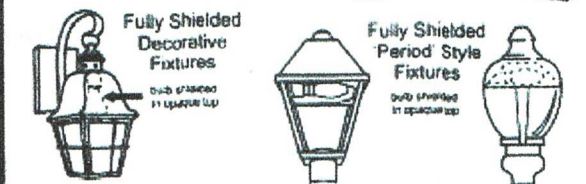
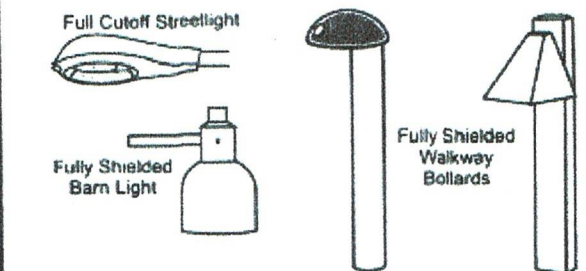
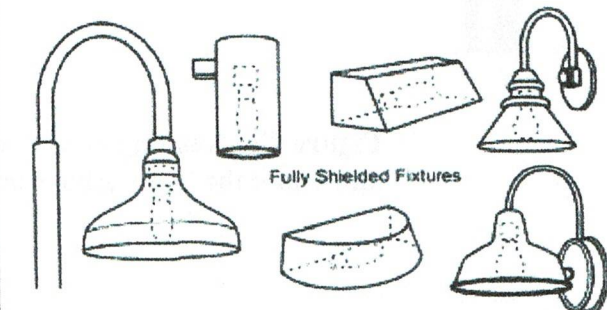
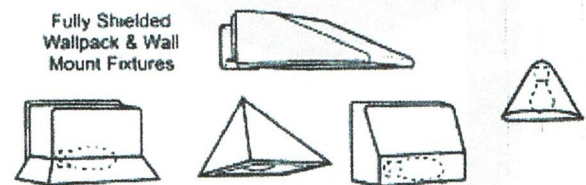
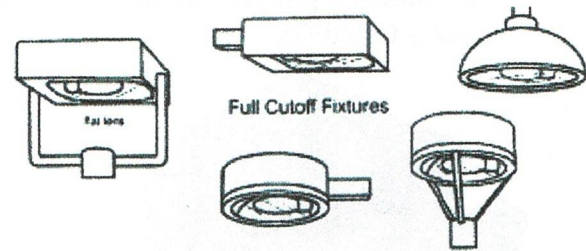

Figure D: The lights on the left are nonconforming due to inadequate shielding. Those on the right can be used in most cases. However, the mounting height and proximity to the property line may require additional shielding to prevent the lamp from being visible from other property.

- (2) AU outdoor light fixtures shall be full cutoff fixtures, except as otherwise permitted by this article (see Figure E for acceptable fixtures and F for unacceptable fixtures).

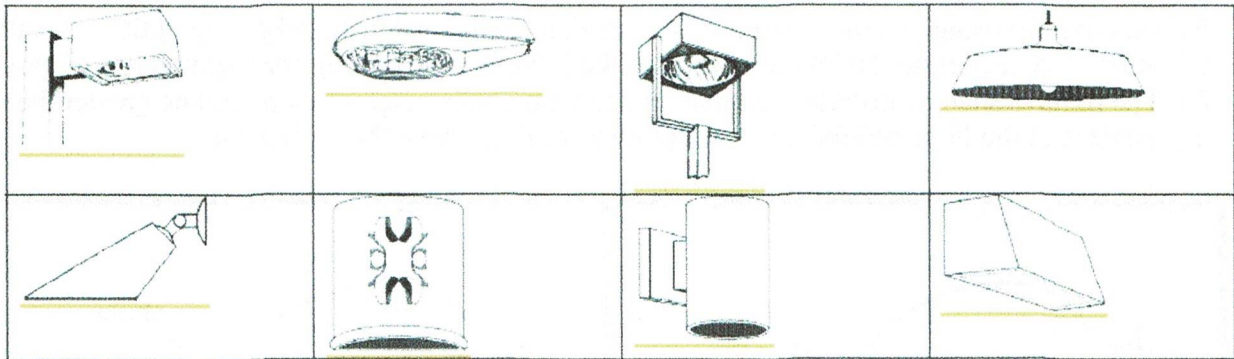

Figure E: Full cutoff fixtures are closed on top and mounted such that the bottom opening is horizontal. The mounting height and location may require additional shielding to prevent the lamp from being visible from any other property. A practical way to determine if a light fixture is a full cutoff fixture is that the lamp, any reflective surface or lens cover (clear or prismatic) is NOT visible when viewed from above or the side.

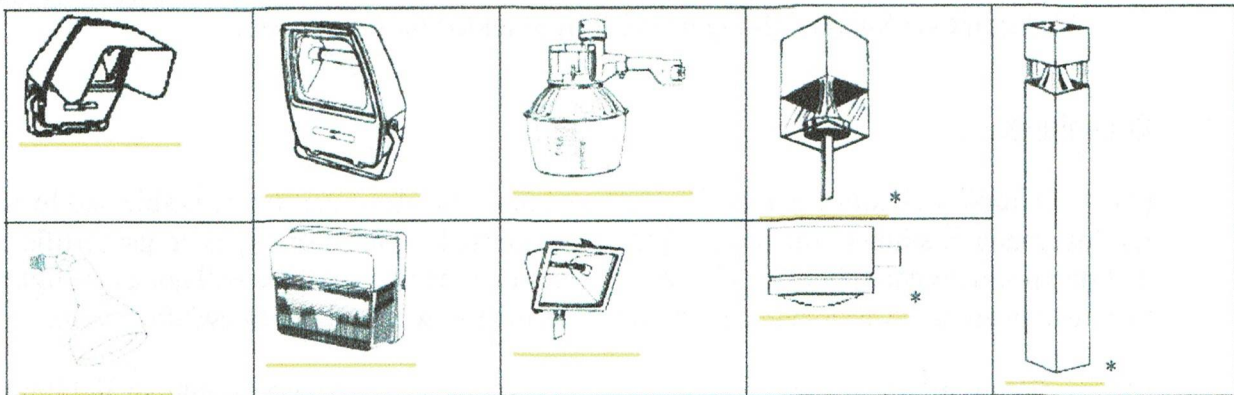

Figure F: This figure illustrates examples of fixtures that are NOT full cutoff fixtures. Note: Even though the lamps in these fixtures are shielded when viewed from the side or above, reflective surfaces within the fixtures or lens covers are directly visible from the side.

C. Output Limits.

(1) Total outdoor light output (excluding governmental owned street lights used for illumination of public rights-of-way and outdoor recreation facilities) of any nonresidential property shall not exceed 100,000 lumens per acre in any contiguous illuminated area.

(2) Total outdoor light output (excluding governmental owned street lights used for illumination of public rights-of-way and outdoor recreation facilities) of any residential property shall not exceed 25,000 lumens per acre in any contiguous illuminated area.

D. Outdoor Recreation Facilities. Outdoor recreation facilities are not subject to output limits. However, outdoor recreational facilities constructed after the effective date of this article are subject to the shielding requirements above. Where fully shielded fixtures are not available, lighting fixtures using external louvers or shields that, in the final installed configuration, extend to within three inches on the lowest portion of the light fixture opening are required (see Figure G). The fixtures shall be installed and maintained with aiming angles that permit no greater than one percent of the light emitted by each fixture to project above the horizontal.

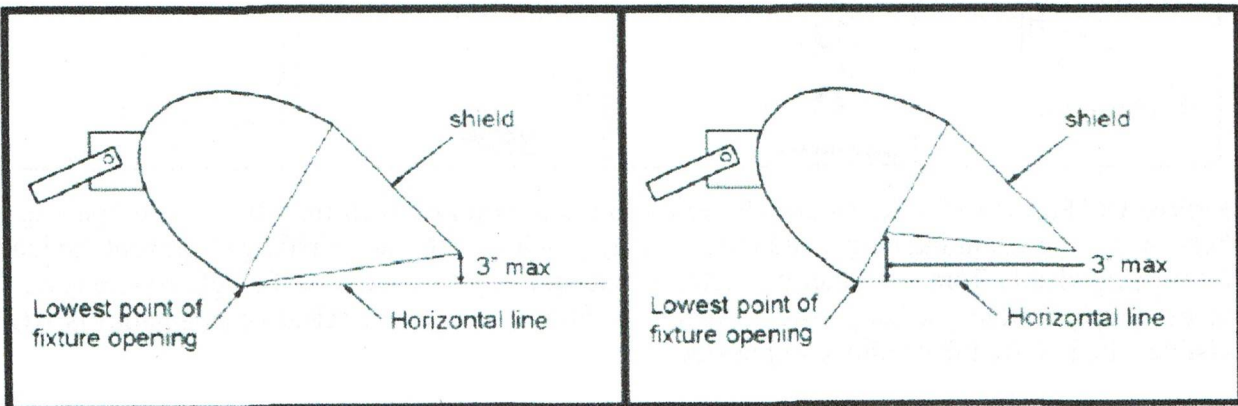

Figure G: Sports lighting where fully shielded fixtures are not available.

E. Prohibitions.

(1) Outdoor uplighting is prohibited, except in cases where the fixture is shielded by a roof overhang or similar structural shield and a licensed architect or engineer has certified and stamped a prepared lighting plan that ensures that the light fixtures will not cause light to extend beyond the structural shield, except as otherwise permitted elsewhere herein.

(2) The installation of any mercury vapor fixture or lamp for use as outdoor lighting is prohibited.

(3) The installation or use of any form of outdoor laser light projection is prohibited.

(4) The operation of searchlights for advertising purposes is prohibited except when associated with a special event lasting no longer than one night.

(5) The installation of any wall pack style fixture for use as outdoor lighting is prohibited unless the fixture is rated by the manufacturer as full cut-off and otherwise complies with the shielding requirements of this article. Examples of acceptable wall packs, when mounted with light directed downward only are shown in Figure H.



Figure H: Examples of acceptable wall packs.

(6) The installation of any barn-light style fixture for use as outdoor lighting is prohibited unless the fixture includes a full opaque reflector instead of the standard translucent lens and otherwise complies with the shielding requirements of this article. An example of barn-light style with and without the required opaque reflector is shown in Figure I.

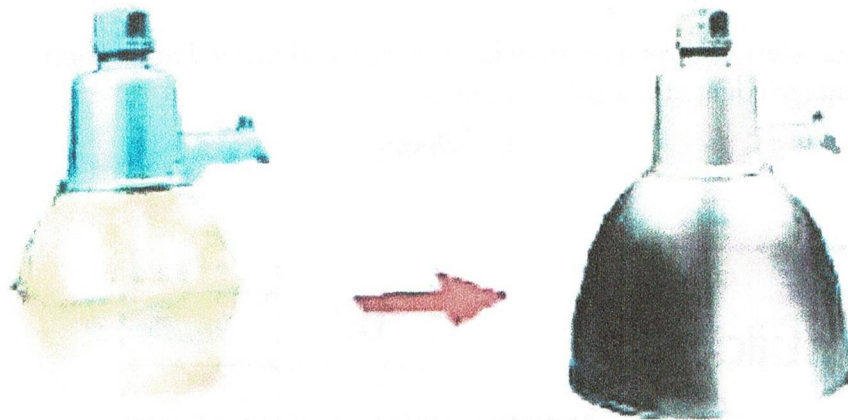

Figure I: Examples of unacceptable and acceptable barn-style light fixture shielding.

Sec. 4.08.006 Lighting under Canopies, Building Overhangs or Roof Eaves

All outdoor or exterior lighting fixtures located under canopies, under building overhangs, or under roof eaves shall conform to all provisions of this article, including the following (see Figures J and K):

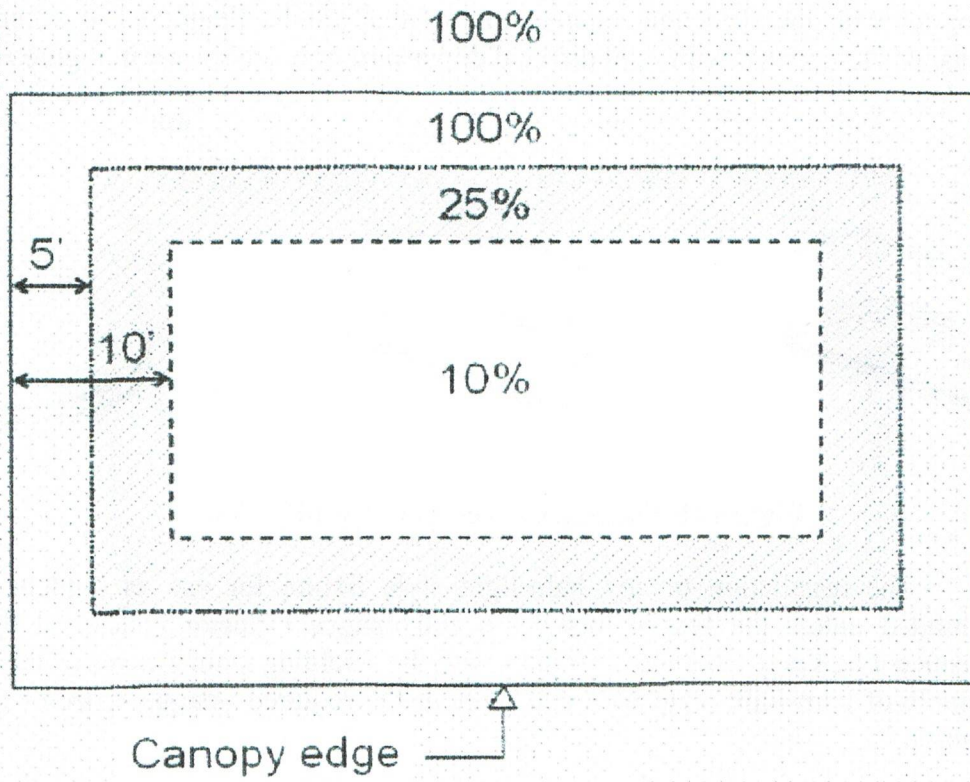

Figure J: Plan view of a canopy, showing fixture location and lumen lamp output percentage counted toward total lumens.

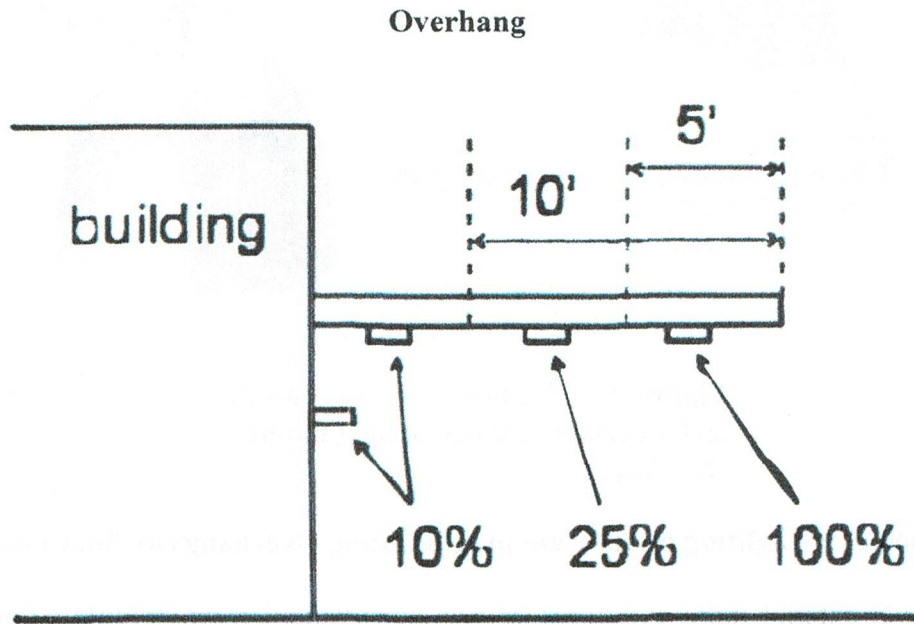

Figure K: Elevation view of a canopy or overhang attached

to a building, showing location of shielded fixtures and the initial lamp output percentage to be used in calculating total output lumens.

A. Outdoor lighting fixtures located under canopies, under building overhangs, or under roof eaves where the nearest edge of the lamp or fixture is located at five or more feet, but less than ten feet from the nearest edge of a canopy, overhang or eave are to be included in the calculation of total outdoor light output as though they produced only one-quarter of the lamp's rated lumen output.

B. Outdoor lighting fixtures located under canopies, under building overhangs, or under roof eaves where the nearest edge of the lamp or fixture is located ten or more feet from the nearest edge of a canopy, building overhang, or eave are to be included in the total outdoor light output as though they produce only one-tenth of the lamp's rated lumen output.

C. The total light output used for illuminating under canopies or building overhangs, defined as the sum of all under canopy initial lamp lumen outputs, shall not exceed 20 lumens per square foot under the canopy area. All lighting mounted under the canopy, including but not limited to, lighting fixtures mounted on the lower surface of the canopy and auxiliary lighting within signage or illuminated panels under the canopy, is to be included in the total.

Sec. 4.08.007 Lighting for Outdoor Signs and Decorative Lighting

A. External Sign Lighting. Outdoor externally illuminated signs shall conform to all provisions of this article sign regulations contained in Sec 11.02.005 Point Venture Code of Ordinances and also signage/illumination requirements contained in Zoning Ordinance 2020-06-18 Sec 1.1.7.3. In particular, such lighting shall conform to the lamp source, shielding restrictions and be included in the output limit calculation. All upward-directed sign lighting is prohibited except as expressly stated otherwise herein.

B. Internal Sign Lighting and Neon Signs.

(1) Outdoor internally illuminated signs (backlit), whether freestanding or building-mounted, shall be constructed with an opaque background and translucent letters and symbols or with a colored background and lighter letters and symbols (see Figure L). The internally illuminated or backlit portion of the sign cannot be white, cream, off-white, or yellow unless it is part of a registered logo. White, cream, off-white or yellow are permitted in the logo only, provided that such colors in the logo shall represent not more than one-third of the total sign area permitted.

Space Intentionally Left Blank





Light Background <input type="checkbox"/>	Colored Background <input checked="" type="checkbox"/>	Opaque Background <input checked="" type="checkbox"/>
		
		

Figure L: Internally illuminated Signs

(2) Lamps used for internal illumination shall not be included in the total outdoor light output calculation.

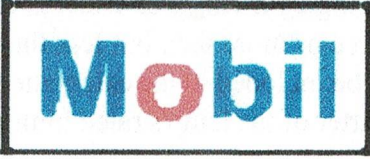
(3) Neon signs shall be treated as internally illuminated signs for the purposes of these regulations and shall not be included in the total outdoor light output calculation. However, neon lighting extending beyond the "sign area" as defined in Section 4.801 below, shall be considered decorative lighting as described below.

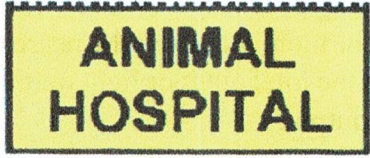
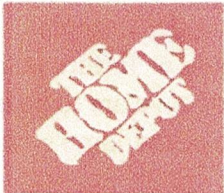
C. Decorative (non-sign) Lighting. Other internally illuminated panels or decorations not considered signage (such as illuminated canopy margins or building panels), shall be considered decorative lighting, and shall be subject to the standards applicable to outdoor or exterior lighting, including but not limited to lamp source, shielding standards and total outdoor light output limits.

D. Destination Wayfinding Sign Lighting. Lighting for destination wayfinding signs shall be provided by ground mounted fixtures directly in front of the sign faces, with light sources shielded from public right-of-ways and limited to arterial street locations. Destination wayfinding signs on other streets shall include reflective surfaces and may not be illuminated.

Sec. 4.08.008 Lighting curfews

A. Nonresidential outdoor or exterior lighting shall not be energized more than 30 minutes after closing or the completion of activities, unless reduced to 25% or less of the total light output allowed.

(1) Motion sensor activation is allowed to cause the light to resume total outdoor light output but shall be reduced back to 25% or less of total outdoor light output allowed within 5

minutes after activation motion has ceased. Light output increases shall not be triggered by activity that occurs on other property.

(2) The required reduction in illumination may be accomplished by dimming, by turning off a certain number of light fixtures, by a combination of the two methods, or by any other action that yields the specified results.

B. Illumination for all advertising signs, both externally and internally illuminated, shall be turned-off by the later of closing time or 10:00 p.m. Illumination for advertising signs may be energized prior to sunrise, but no more than one hour prior to opening.

C. Street lighting, other than at the intersection of roadways, shall utilize half night photocells or timers to turn off the lights halfway between dusk and dawn.

Section 3. Savings/Repealing Clause. All provisions of any ordinance in conflict with this Ordinance are hereby repealed to the extent they are in conflict; but such repeal shall not abate any pending prosecution for violation of the repealed ordinance, nor shall the repeal prevent a prosecution from being commenced for any violation if occurring prior to the repeal of the ordinance. Any remaining portions of said ordinances shall remain in full force and effect.

Section 4. Severability. Should any section, subsection, sentence, clause, phrase of this Ordinance be declared unconstitutional or invalid by a court of competent jurisdiction, it is expressly provided that any and all remaining portions of this Ordinance shall remain in full force and effect. Village of Point Venture hereby declares that it would have passed this Ordinance, and each section, subsection, sentence, clause or phrase thereof irrespective of the fact that any one or more sections, subsections, sentences, clauses and phrases be declared unconstitutional or invalid.

Section 5. Open Meeting. The Village Council hereby finds and determines that the meeting at which this Ordinance was adopted was open to the public and that public notice of the time, place and purpose of said meeting was given as required by the Open Meetings Act, Chapter 551 of the Texas Government Code.

Section 6. Effective Date. This Ordinance shall become effective immediately upon its adoption and its publication as required by law.

DULY PASSED AND ADOPTED by the Village Council of the Village of Point Venture, Texas, on the 24th day of February, 2021.

VILLAGE OF POINT VENTURE

Eric Love, Mayor

ATTEST:

APPROVED AS TO FORM :

Vickie Knight

Vickie Knight, Village Secretary

Monte Akers